

## DS-2AE4225T-D

### 2 MP Turbo 4-Inch Speed Dome



- 1/2.8" HD Progressive Scan CMOS
- 1920 × 1080 Resolution
- 25x Optical Zoom, 16x Digital Zoom
- 120 dB True WDR (Wide Dynamic Range)
- 3D Intelligent Positioning
- Switchable TVI/AHD/CVI/CVBS Video Output

Hikvision's DS-2AE4225T-D Turbo 4-Inch Speed Dome is able to capture high quality images in poor light environments. The embedded CMOS chip makes WDR and real-time 1920 × 1080 resolution possible. With the help of the 25x optical zoom and IR cut filter, the camera offers more details over an expansive area.

#### Order Model

DS-2AE4225T-D









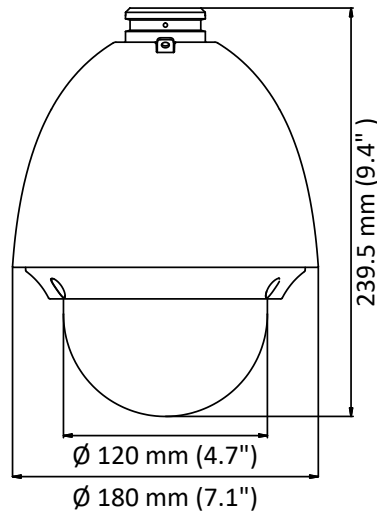

# Specifications

DS-2AE4225T-D	
<b>Camera</b>	
Image Sensor	1/2.8" progressive scan CMOS
Maximum Image Resolution	1920 × 1080
Frame Rate	50 Hz: 25 fps @ (1920 × 1080) 60 Hz: 30 fps @ (1920 × 1080)
Minimum Illumination	Color: 0.005 lux @ (f/1.6, AGC on) B/W: 0.001 lux @ (f/1.6, AGC ON)
White Balance	Auto/manual/hauto/atw/indoor/outdoor
AGC	Auto/manual
DNR	3D DNR
WDR	≥120 dB
Shutter Speed	PAL: 1/1 s to 1/10,000 s NTSC: 1/1 s to 1/10,000 s
Day/Night	IR cut filter
Digital Zoom	16x
Privacy Mask	8 programmable privacy masks
BLC (Backlight Compensation)	Yes
HLC (High Light Compensation)	Yes
EIS (Electric Image Stabilization)	Yes
Regional Focus	Yes
<b>Lens</b>	
Focus Mode	Auto/semi-auto/manual
Focal Length	4.8 mm to 120 mm, 25x optical
Aperture Range	f/1.6 to f/3.5
Field of View	Horizontal field of view: 57.6° to 2.5° (wide to tele) Vertical field of view: 34.4° to 1.4° (wide to tele) Diagonal field of view: 64.5° to 2.9° (wide to tele)
Minimum Working Distance	10 mm to 1500 mm (wide to tele)
Zoom Speed	Approximately 3.6 s (optical, wide to tele)
<b>Pan and Tilt</b>	
Pan Range	360° endless
Pan Speed	Pan manual speed: 0.1° to 100°/s Pan preset speed: 100°/s
Tilt Range	-5° to 90° (auto flip)
Tilt Speed	Tilt manual speed: 0.1° to 80°/s Tilt preset speed: 80°/s
Proportional Zoom Presets	Rotation speed can be adjusted automatically according to zoom multiples 256
Patrol Pattern	10 patrols, up to 32 presets per patrol 5 patterns, with the total recording time no less than 10 minutes
Power-Off Memory	Yes
Park Action	Preset/patrol/pattern/pan scan/tilt scan/panorama scan/day mode/night mode/none
PTZ Position Display	ON/OFF
Preset Freezing	Yes
Scheduled Task	Preset/patrol/pattern/pan scan/tilt scan/panorama scan/day mode/night mode/zero calibration/none
<b>Input/Output</b>	
Video Output	Switchable TVI/AHD/CVI/CVBS video output, (NTSC or PAL composite, BNC)
Alarm	2 alarm input, 1 alarm output
RS-485 Interface	Half-duplex mode Self-adaptive HIKVISION, Pelco-P, Pelco-D protocol
UTC function	UTC protocol (or HIKVISION-C protocol in previous DVR)
<b>General</b>	
Menu Language	English
Power	12 VDC, maximum 16 W
Working Temperature	-30° to 65° C [-22° to 149° F]
Working Humidity	90% or less, non-condensing
Protection Level	IP66 standard (outdoor dome) TVS 4,000 V lightning protection, surge protection, and voltage transient protection
Mounting	Various mounting modes optional
Dimension	Ø179.4 mm × 239.5 mm (Ø7.1" × 9.4")
Weight (approximate)	2 kg (4.41 lb)

# Dimensions



# Accessories

INCLUDED	NOT INCLUDED			
				
<b>WMP-S</b> Wall Mount-Short	<b>CPM-S</b> Ceiling Pendant Mount-Short	<b>RPM</b> Roof Parapet Mount	<b>CPM-L</b> Ceiling Pendant Mount-Long	<b>CMP</b> Corner Mount
				
	<b>PMP</b> Horizontal Pole Mount	<b>JBPW-L</b> Wall Mount w/Junction Box	<b>CMP-JB</b> Corner Mount	<b>PMP-JB</b> Pole Mount
				
<b>WMP-L</b> Wall Mount-Long				