

DS-2DE7530IW-AE

Value Series 5 MP 30× IR Outdoor Network Speed Dome



The Hikvision DS-2DE7530IW-AE 5 MP 30x IR Outdoor Network Speed Dome features a 1/1.9" progressive scan CMOS sensor for a 2592 x 1944 high resolution image. It also features a 30x optical zoom (16x digital zoom), IR distance up to 492 ft (150 m), defog, EIS (Electronic Image Stabilization), 3D DNR (Dynamic Noise Reduction), BLC (Backlight Control), HLC (Highlight Compensation), and digital WDR (Wide Dynamic Range).

- 1/1.9" Progressive Scan CMOS
- Up to 2592 x 1944 Resolution
- 30× Optical Zoom, 16× Digital Zoom
- IR Distance up to 492 ft (150 m)
- Defog, EIS, 3D DNR, BLC, HLC, Digital WDR
- Basic Smart Suite Analytics
- Auto-Tracking
- H.265+/H.265 Video Compression
- IP66, IK10
- 24 VAC, Hi-PoE (Injector Included), 40 W











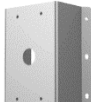

Specifications

DS-2DE7530IW-AE	
Camera Module	
Image Sensor	1/1.9" progressive scan CMOS
Minimum Illumination	Color: 0.005 lux @ (f/1.5, AGC on); B/W: 0.002 lux @ (f/1.5, AGC on); 0 lux with IR
Shutter Speed	1/1 s to 1/30,000 s
White Balance	Auto/manual/ATW/indoor/outdoor/daylight lamp/sodium lamp
AGC	Auto/manual
Day/Night	IR cut filter
Digital Zoom	16x
Privacy Mask	8 programmable privacy masks
Focus Mode	Auto/semiautomatic/manual
3D DNR	Supported
BLC	Supported
HLC	Supported
Digital WDR	92 dB
Defog	Supported
EIS	Supported
Regional Exposure	Supported
Regional Focus	Supported
Lens	
Focal Length	5.9 to 177 mm, 30x optical zoom
Zoom Speed	Approximately 4.8 s (optical wide-tele)
Angle of View	51.3° to 2.7° (wide-tele)
Minimum Working Distance	10 mm to 1500 mm (wide-tele)
Aperture Range	f/1.5 to f/3.4
PTZ	
Movement Range (Pan)	360° endless
Pan Speed	Configurable, from 0.1°/s to 160°/s, preset speed: 240°/s
Movement Range (Tilt)	From -15° to 90° (auto flip)
Tilt Speed	Configurable, from 0.1°/s to 120°/s, preset speed: 200°/s
Proportional Zoom	Supported
Presets	300
Patrol Scan	8 patrols, up to 32 presets for each patrol
Pattern Scan	4 pattern scans, record time over 10 minutes for each scan
Auto-Tracking	Supported
Power-Off Memory	Supported
Park Action	Preset/pattern scan/patrol scan/auto scan/tilt scan/random scan/ frame scan/panorama scan
PTZ Status Display	Supported
Preset Freezing	Supported
Scheduled Task	Preset/pattern scan/patrol scan/auto scan/tilt scan/random scan/frame scan/panorama scan/dome reboot/dome adjust/aux output
Smart Features	
Basic Event Detection	Motion detection, video tampering, alarm input, alarm output, exception
Smart Event Detection	Audio exception detection, face detection, intrusion detection, line crossing detection, region entrance detection, region exiting detection
Smart Record	ANR (Automatic Network Replenishment), dual-VCA
Infrared	
IR Distance	492 ft (150 m)
Smart IR	Supported
IR Control	IR brightness and angle are intelligently adjustable according to the scenes
Network	
Maximum Resolution	2592 x 1944
Main Stream	30 fps (2592 x 1944, 2560 x 1536, 2048 x 1536, 1920 x 1080, 1280 x 960, 1280 x 720); 60 fps (1920 x 1080, 1280 x 960, 1280 x 720)
Sub-Stream	30 fps (704 x 480, 640 x 480, 352 x 240)
Third Stream	30 fps (1920 x 1080, 1280 x 960, 1280 x 720, 704 x 480, 640 x 480, 352 x 240)
ROI	Supported
Video Compression	Main stream: H.265+/H.265/H.264+/H.264 sub-stream: H.265/H.264/MJPEG; third stream: H.265/H.264/MJPEG
Audio Compression	G.711 alaw/G.711 ulaw/G.722.1/G.726/MP2L2/PCM
Protocols	IPv4/IPv6, HTTP, HTTPS, 802.1x, QoS, FTP, SMTP, UPnP, SNMP, DNS, DDNS, NTP, RTSP, RTP, TCP, UDP, IGMP, ICMP, DHCP, PPPoE, Bonjour
Simultaneous Live View	Up to 20 channels
User/Host	Up to 32 users, 3 levels: administrator, operator, and user
Security Measures	User authentication (ID and PW), host authentication (MAC address), IP address filtering
System Integration	
Alarm Input	2-ch alarm input
Alarm Output	1-ch alarm output
Alarm Linkage	Preset, patrol scan, pattern scan, memory card video recording, trigger recording, E-map, VCA capture, upload to ftp, send e-mail, etc.
Audio Input	1-ch audio input
Audio Output	1-ch audio output
Network Interface	1 RJ-45 10 M/100 M Ethernet interface, Hi-PoE
Storage	Built-in memory card slot, supports microSD/SDHC/SDXC, up to 128 GB, NAS (NPS, SMB/CIFS), ANR
API	Open-ended, supports ONVIF, PSIA, and CGI, supports Hikvision SDK and third-party management platforms
Client	iVMS-4200, iVMS-4500
Web Browser	IE 8+, Chrome 31+, Firefox 30+, Safari 8.0+ Web browser

Specifications (continued)

General	
Power	24 VAC and Hi-PoE, maximum: 40 W, supplementary light 19 W
Working Temperature	Outdoor: -22° to 149° F (-30° to 65° C)
Working Humidity	≤90% non-condensing
Protection Level	IP66 standard, TVS 4000 V lightning protection, surge protection, and voltage transient protection
Dimensions	Ø8.66" × 13.91" (Ø220 mm × 353.4 mm)
Weight	Approximately 9.92 lbs (4.5 kg)

Accessories

WMP-L and WMP-S Compatible		NOT INCLUDED			INCLUDED	
		JBPW-L Compatible				
						
WMP-S Short Wall Mount for 4" PTZ	WMP-L Wall Mount PTZ, Long	JBPW-L PTZ Junction Box w/Wall Bracket	CMP-JB Corner Mount	PMP-JB Pole Mount	RPM Roof Parapet Mount	(actual product appearance may vary) G1.5 Adapter Converts Hikvision Quick Release To G1.5" Thread
		CPM-S and CPM-L Compatible				
						
CMP Corner Mount	PMP Pole Mount	CPM-S Ceiling Pendant Mount, Short	CPM-L Ceiling Pendant Mount, Long	CPMPE CPM Extension 1.5" Diameter		

Dimensions (units: mm)

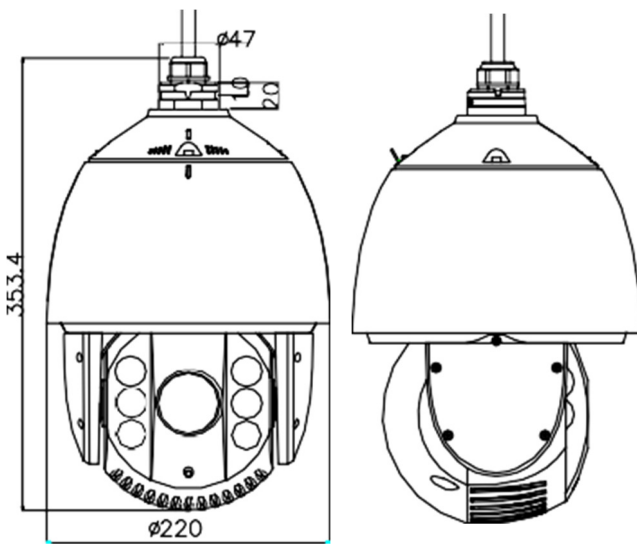

Box Contents (Subject To Change without Notice)

PoE injector
Power Cord
Quick Start Guide
Quick Release to 1.5" Adapter
Watertight Cable Connector
Wrench