

DS-2TD4166-25/50

Thermal & Optical Bi-spectrum Network Speed Dome



- 640 x 512 Resolution
- Vanadium Oxide Uncooled Focal Plane Arrays
- 25 mm, 50 mm Lens Options
- NETD <40 mk
- Adaptive AGC, 3D DNR
- Dynamic Detail Enhancement
- Smart Features:
 - Line Crossing, Intrusion, Region Entrance/Exit
 - Temperature Exception
 - Advanced Fire Detection
 - Smart Tracking
- Temperature Range: -4° F to 1,022° F (-20° C to 550° C)
- Temperature Accuracy: Maximum ($\pm 2^\circ \text{C}$, $\pm 2\%$)
- 15 Psuedo Colors Adjustable
- IP66 Protection
- 24 VAC, 60 W

The Hikvision DS-2TD4166-25, and DS-2TD4166-50 Thermal & Optical Bi-spectrum Network Speed Dome use a vanadium oxide uncooled focal plane sensor to enhance thermal image quality.

The high sensitivity sensor has 640 x 512 resolution and features contrast adjustment for optimized images. AGC (Automatic Gain Control), 3D DNR (Dynamic Noise Reduction), and Dynamic Detail Enhancement further enhance image quality.

This series of cameras also features advanced fire detection and a wide range of Smart functions, including temperature exception, line crossing, intrusion, and region entrance and exit, benefitting users with great improvements in security efficiency and, more importantly, with key events and objects being recorded for further forensic needs.

The cameras can be outfitted with 25 mm or 50 mm lens to cover a variety of needs.

Available Models:

DS-2TD4166-25 (25 mm lens)
DS-2TD4166-50 (50 mm lens)



Specifications







DS-2TD4166-25		DS-2TD4166-50
Thermal Module		
Image sensor	Vanadium oxide uncooled focal plane arrays	
Maximum Resolution	640 × 512	
Detector Pitch	1.7µm	
Response waveband	8µm to 14µm	
NETD	< 40mk (@ 25° C, F# = 1.0)	
Lens (focal length)	25 mm	50 mm
MRAD	0.68 mrad	0.34 mrad
Field of View	24.55° × 19.75°	12.42° × 9.95°
Minimum Focusing Distance	2 m	7.5 m
F number	1.0	
Optical Camera		
Image Sensor	1/1.9" progressive scan CMOS	
Minimum Illumination	Color: 0.002 lux @ (F1.5, AGC On); B/W: 0.0002 lux @ (F1.5, AGC On)	
Focal Length	5.7 to 205.2 mm, 36x	
Digital Zoom	16x	
Field of View	58.7° to 2.0° (wide to tele)	
Minimum Working Distance	10 to 1,500mm (wide to tele)	
Aperture Range	F1.5 to F4.5	
Focus Mode	Auto / semiautomatic / manual	
WDR	120dB	
Shutter Time	PAL: 1 to 1/30,000s / NTSC: 1 to 1/30,000s	
White Balance	Auto / manual / ATW / indoor / outdoor / daylight lamp / sodium lamp	
Day & Night	IR Cut Filter	
Privacy Mask	24 privacy masks programmable; optional multiple colors and mosaics	
Optical Defog	Yes	
Enhancement	3D DNR	
Smart Function		
VCA	Supports 4 VCA rule types (line crossing, intrusion, region entrance, and region exiting), 10 scenes, and 8 VCA rules for each scene	
Temperature Measurement	Supports 3 temperature measurement rule types, over 256 presets, and 21 rules (10 points, 10 regions, and 1 line) for each scene	
Temperature Range	-4° F to 302° F (-20° C to 150° C)	
Temperature Accuracy	± 8° C [14.4° F]	
Fire Detection	Supports 10 fire points	
PTZ		
Movement Range	Pan: 360° continuous rotate; tilt: from -15° to + 90° (auto flip)	
Pan Speed	Configurable, from 0.1°/s to 160°/s, preset speed: 240°/s	
Tilt Speed	Configurable, from 0.1°/s to 120°/s, preset speed: 200°/s	
Proportional Zoom	Yes	
Presets	300	
Patrol Scan	8; up to 32 presets per patrol	
Pattern Scan	4; more than 10 minutes per pattern	
Power Off Memory	Yes	
Park	Preset / pattern scan / patrol scan / auto scan / tilt scan / random scan / frame scan / panorama scan	
PT Status	Turn on / turn off	
Scheduled Task	Preset / pattern scan / patrol scan / auto scan / tilt scan / random scan / frame scan / panorama scan / doom reboot / doom adjust / aux output	
Infrared		
IR Distance	Up to 655 ft (200 m)	
IR Intensity and Angle	Auto adjust	
Network		
Main Stream	Optical: 50 Hz: 25 fps (1920×1080), 25 fps (1280×960), 25 fps (1280×720); 60 Hz: 30 fps (1920×1080), 30 fps (1280×960), 30 fps (1280×720) Thermal: 50 fps (640 × 512)	
Sub-Stream	50 Hz: 25 fps (704 × 576), 25 fps (352 × 288), 25 fps (176 × 144); 60 Hz: 30 fps (704 × 480), 30 fps (352 × 240), 30 fps (176 × 120) Thermal: 50 fps (640 × 512)	
Video Compression	H.264 (Baseline/Main/High Profile) / MJPEG / MPEG4	
Audio Compression	G.711u / G.711a / G.722.1 / MP2L2 / G.726 / PCM	
Protocols	IPv4 / IPv6, HTTP, HTTPS, 802.1x, Qos, FTP, SMTP, UPnP, SNMP, DNS, DDNS, NTP, RTSP, RTCP, RTP, TCP, UDP, IGMP, ICMP, DHCP, PPPoE, Bonjour	
Simultaneous Live View	Up to 20-ch	
User/Host Level	Up to 32 users, 3 levels: administrator, operator, user	
Security Measures	User authentication (ID and PW), MAC address binding, HTTPS encryption, IEEE 802.1x access control, IP address filtering	
Integration		
Alarm Input	Up to 7-ch inputs (0 to 5 VDC)	
Alarm Output	Up to 2-ch relay outputs, supports alarm linkage	
Alarm Action	Preset / patrol scan / pattern scan / SD card record / relay output / smart capture / FTP upload / email linkage	
Audio Input	Line in input / microphone input; peak: from 2 to 2.4 V(p-p); output impedance: 1kΩ ± 10%	
Audio Output	Linear level; impedance: 600 Ω	
Communication Interface	Built-in RJ45; 10M/100M Ethernet Interface	
Onboard Storage	Built-in microSD / SDHC / SDXC card slot, up to 64 GB; supports manual / alarm recording	
Ethernet	1 RJ45 10M/100M Self-adaptive Ethernet interface	
Analog Video Output	1.0V [p-p] / 75 Ω, PAL / NTSC / BNC	
RS-485	Half-duplex; HIKVISION, PELCO-P and PELCO-D self-adaptive	
API	Open-ended API, supports ISAPI; supports HIKVISION SDK and third-party management platforms	
Client	iVMS-4200	
Web Browser	IE 7+, Chrome 18+, Firefox 5.0+, Safari 5.02+; Multiple Languages	
General		
Menu	English	
Power	24 VAC, 60 W	
Work Temperature/Humidity	From -40° F to 140° F (-40° C to 65° C); Humidity: 90% or Less	
Protection Level	IP66 standard; TVS 6000V lightning protection, surge protection and voltage transient protection	
Weight	17.64 lbs (8 kg)	

Range Performance¹

Standard Range Table	Model			
	DS-2TD4166-25		DS-2TD4166-50	
Johnson Criteria	Human	Vehicle	Human	Vehicle
Detection	2,411 ft (735 m)	7,398 ft (2,255 m)	4,826 ft (1,471 m)	14,797 ft (4,510 m)
Recognition	604 ft (184 m)	1,850 ft (564 m)	1,207 ft (368 m)	3,698 ft (1,127 m)
Identification	302 ft (92 m)	925 ft (282 m)	604 ft (184 m)	1,850 ft (564 m)

Smart Functions Range Table	Object	Model	
		DS-2TD4166-25	DS-2TD4166-50
Line Cross/Intrusion/Region Entrance-Exit	Human	604 ft (184 m)	1,181 ft (360 m)
	Vehicle	1,686 ft (514 m)	3,698 ft (1,127 m)
Optimized to Johnson Criteria (Recognition)	Human	604 ft (184 m)	1,181 ft (360 m)
Temperature Exception	Size of Point	Max Range	Max Range
Accuracy at 5 x 5 pixels	2 m x 2 m	1,919 ft (585 m)	3,839 ft (1,170 m)
	1 m x 1 m	968 ft (295 m)	1,936 ft (590 m)
Advanced Fire Detection	Size of Point	Max Range	Max Range
Accuracy at 2 x 2 pixels	2 m x 2 m	4,822 ft (1,470 m)	9,646 ft (2,940 m)
	1 m x 1 m	2,411 ft (735 m)	4,822 ft (1,470 m)

Accessories

						
WMP-L Long Wall Mount	CMP Large Corner Mount for WMP-S/L	PMP Pole Mount for WMP-S/L	JBPW-L Power Box Mount w/Wall Bracket	CPM-S Short Ceiling Pendant Mount	CPM-L Long Ceiling Pendant Mount	CPMPE Ceiling Pendant Mount Extension Pipe

Dimensions

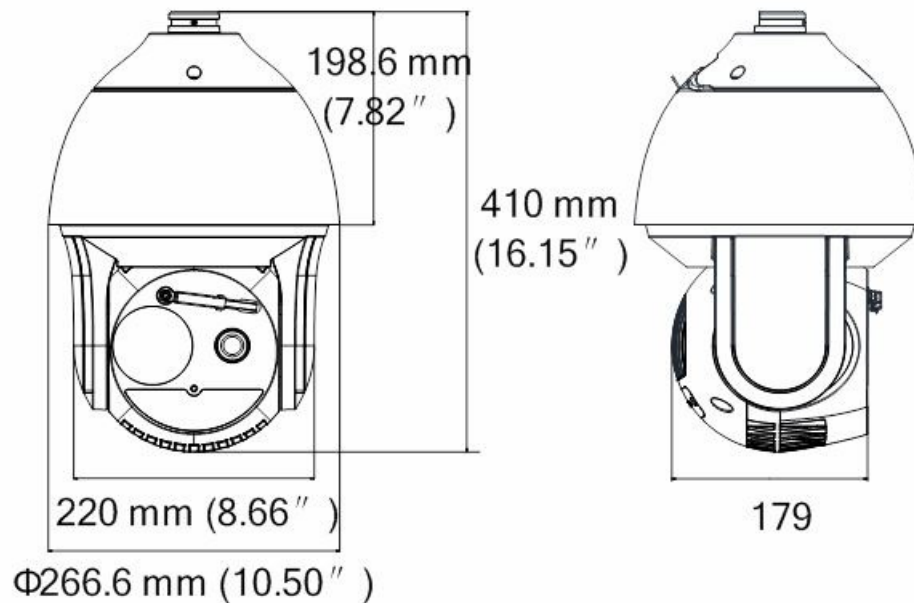

¹ Range performance values are calculated under ideal conditions and are not a guarantee of performance.