

## EPI-5225I-DE

### 2 MP Outdoor 25× Network IR Speed Dome



- **1/2.8" Progressive Scan CMOS**
- **Up to 1920 x 1080 Resolution**
- **Minimum Illumination:**  
Color: 0.005 Lux @ (f/1.6, AGC on)  
B/W: 0.001 Lux @ (f/1.6, AGC on)  
0 Lux with IR
- **Up to 490 ft (150 m) IR Range**
- **H.264+/H.264 Video Compression**
- **25x Optical Zoom, 16x Digital Zoom**
- **Smart Detection: Line Crossing, Intrusion, Region Enter/Exit**
- **Smart IR, EIS, Defog**
- **120 dB WDR**
- **IP66 Protection**
- **24 VAC and PoE+ (IEEE802.3 at), 18 W**

Hikvision EPI-5225I-DE Network IR Speed Dome Cameras produce images with a resolution of up to 1920 x 1080 pixels.

The embedded 1/2.8" progressive scan CMOS chip supports 120 dB WDR, and the 25x optical zoom allows for greater detail to be collected over more expansive areas.

The Network IR Speed Dome Camera also features a wide range of smart functions, including intrusion detection, line crossing detection, and audio exception, which allows for key events and objects to be recorded for further forensic needs.

**Available models:**  
EPI-5225I-DE



# Specifications

## EPI-5225I-DE

### Camera Module

Image Sensor	1/2.8" progressive scan CMOS
Minimum Illumination	Color: 0.005 Lux @ (f/1.6, AGC on); B/W: 0.001 Lux @ (f/1.6, AGC on); 0 Lux with IR
Shutter Speed	1/1 to 1/30,000 s
White Balance	Auto/manual/ATW [auto-tracking white balance]/indoor/outdoor/fluorescent lamp/sodium lamp
AGC	Auto/manual
Day/Night	IR cut filter
Digital Zoom	16x
Privacy Mask	24 programmable privacy masks
Focus Mode	Auto/semi-automatic/manual
WDR	120 dB

### Lens

Focal Length	4.8 mm to 120 mm, 25x optical zoom
Zoom Speed	Approximately 3.2 s (optical lens, wide to tele)
Angle of View	Horizontal field of view: 57.6° to 2.5° (wide to tele); vertical field of view: 34.4° to 1.4° (wide to tele); diagonal field of view: 64.5° to 2.9° (wide to tele)
Minimum Working Distance	10 mm to 1,500 mm (wide to tele)
Aperture Range	f/1.6 to f/3.5

### IR

IR Distance	Up to 490 ft (150 m)
Smart IR	Supported

### PTZ

Movement Range (Pan)	360° endless
Pan Speed	Configurable, from 0.1°/s to 120°/s, Preset Speed: 120°/s
Movement Range (Tilt)	From -15° to 90° (auto-flip)
Tilt Speed	Configurable, from 0.1°/s to 80°/s, Preset Speed: 80°/s
Proportional Zoom	Supported
Presets	300
Patrol Scan	8 patrols, up to 32 presets for each patrol
Pattern Scan	4 pattern scans, record time over 10 minutes for each scan
Power-Off Memory:	Supported
Park Action	Preset/pattern scan/patrol scan/auto scan/tilt scan/random scan/frame scan/panorama scan
PTZ Status Display	Supported
Preset Freezing	Supported
Scheduled Task	Preset/pattern scan/patrol scan/auto scan/tilt scan/random scan/frame scan/panorama scan/dome reboot/dome adjust/aux output

### Compression Standard

Video Compression	Main stream: H.264+ / H.264; sub-stream: H.264 / MJPEG; third stream: H.264 / MJPEG
H.264 Type	Baseline profile/ main profile / high profile
H.264+	Supported
Video Bitrate	32 kbps to 16,384 kbps
SVC	Supported

### Smart Features

Basic Event Detection	Motion detection, video tampering detection, exception detection
Smart Event Detection	Intrusion detection, line crossing detection, region entrance detection, region exiting detection, unattended baggage detection, object removal detection
ROI encoding	Main stream, sub-stream and third stream respectively support four fixed areas
Smart Record	ANR (Automatic Network Replenishment), Dual-VCA

### Image

Maximum Resolution	1920 x 1080
Main Stream	30 fps (1920 x 1080, 1280 x 960, 1280 x 720)
Sub-Stream	30 fps (704 x 480, 640 x 480, 352 x 240)
Third Stream	30 fps (1920 x 1080, 1280 x 960, 1280 x 720, 704 x 480, 640 x 480, 352 x 240)
Image Enhancement	HLC/BLC/3D DNR/Defog/EIS/Regional Exposure/Regional Focus

### Network

Network Storage	Built-in memory card slot, support for microSD/SDHC/SDXC, up to 256 GB; NAS (NFS, SMB/CIFS), ANR
Protocols	IPv4/IPv6, HTTP, HTTPS, 802.1x, Qos, FTP, SMTP, UPnP, SNMP, DNS, DDNS, NTP, RTSP, RTCP, RTP, TCP/IP, UDP, IGMP, ICMP, DHCP, PPPoE, Bonjour
API	Open-ended, support ONVIF, ISAPI, and CGI, support for HIKVISION SDK and third-party management platforms
Simultaneous Live View	Up to 20 channels
User/Host	Up to 32 users. Three levels: administrator, operator, and user
Security Measures	User authentication (ID and PW), Host authentication (MAC address); HTTPS encryption; IEEE 802.1x port-based network access control; IP address filtering
Client	iVMS-4200, iVMS-4500, Hik-Connect
Web Browser	IE 8 to 11, Chrome 31.0 to 44, Firefox 30.0 to 51











### Interface

Network Interface	1-port RJ45 10 M/100 M Ethernet Interface; PoE+ (802.3at, class4)
-------------------	---

### General

Power	24 VAC and PoE+ (802.3at, class4), maximum: 18 W
Working Temperature	-22° F to 149° F (-30° C to 65° C); humidity: ≤ 90%
Protection Level	IP66 standard, TVS 4000V lightning protection, surge protection and voltage transient protection
Material	ADC 12, PC+10% GF
Dimensions	Ø 8.40" x 13.58" (Ø 213.4 mm x 345 mm)
Weight	Approximately 7.28 lbs (3.3 kg)

## Accessories

										
<b>WMP-L</b> Wall Mount PTZ Long	<b>CMP</b> Corner Mount for WMP-S/L	<b>PMP</b> Pole Mount for WMP-S/L	<b>JBPW-L</b> Power Box Mount w/Wall Bracket	<b>CMP-JB</b> Corner Mount for JBPW-L	<b>PMP-JB</b> Pole Mount for JBPW-L	<b>CPM-S</b> Short Ceiling Pendant Mount	<b>CPM-L</b> Long Ceiling Pendant Mount	<b>CPMPE</b> Ceiling Pendant Mount Extension Pipe	<b>PMP-V</b> Horizontal Pole Mount for CPM-S/L	<b>RPM</b> Roof Parapet Mount

## Dimensions

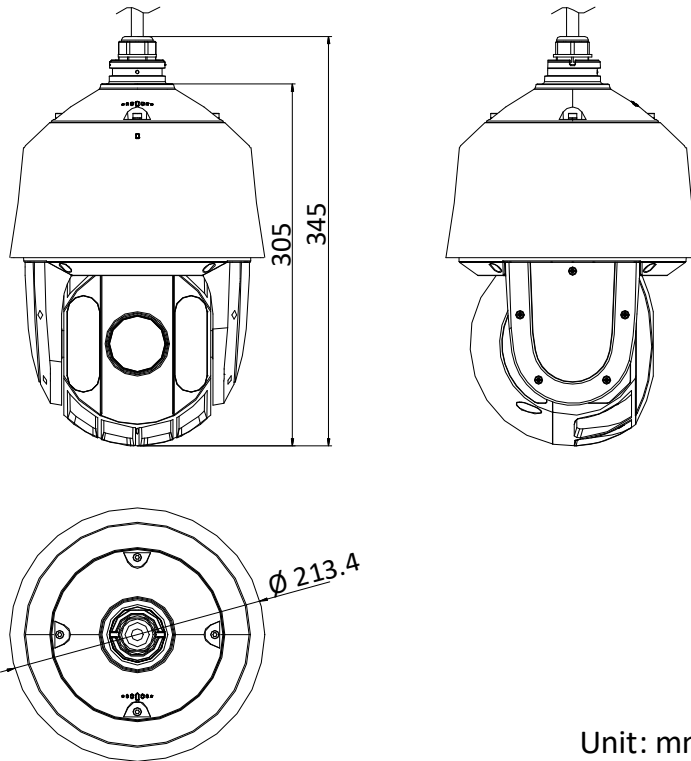

Unit: mm